

## PROGRAMMÜBERSICHT

Program overview

Programma overzicht

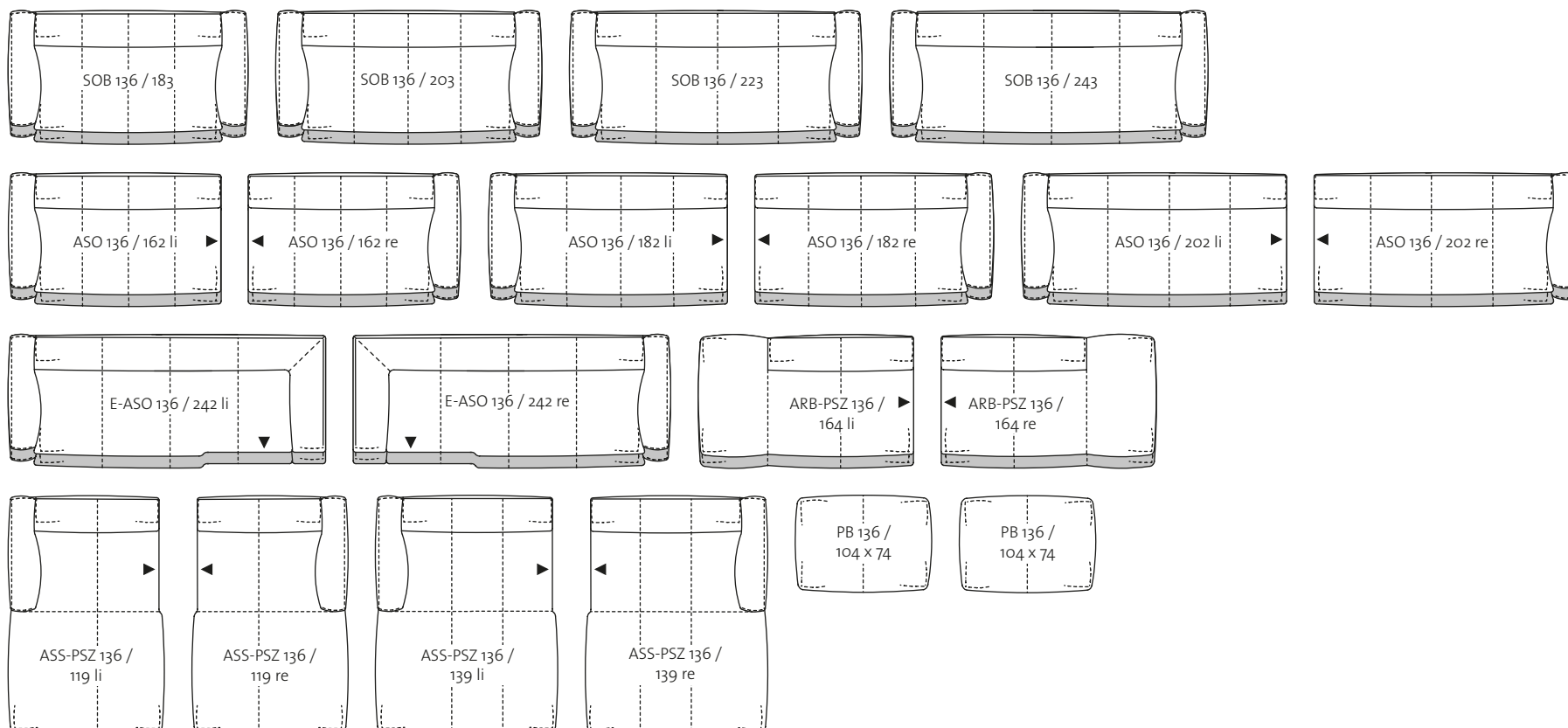

## KOMBINATIONENBEISPIELE

Combination examples

Voorbeelden van combinaties

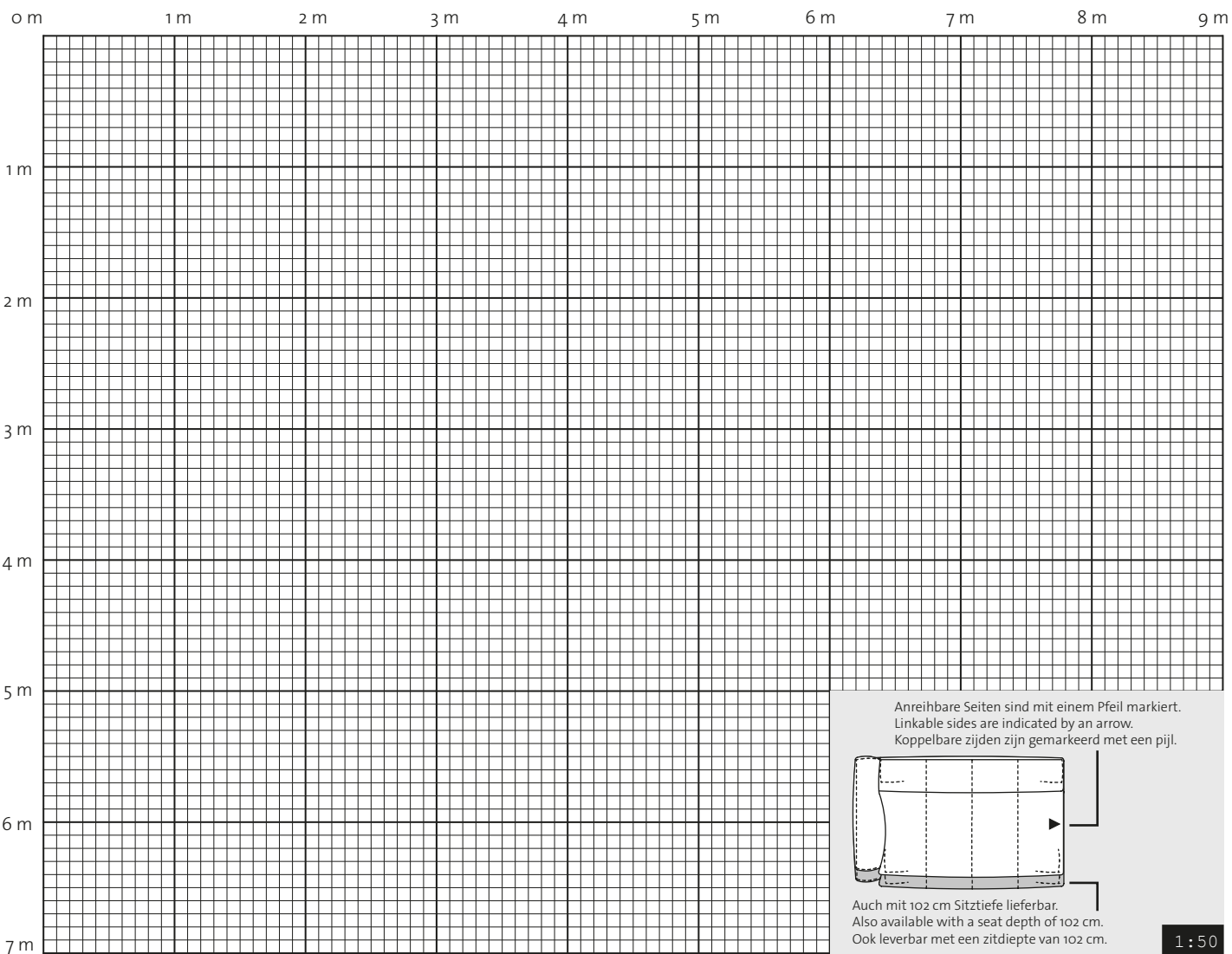
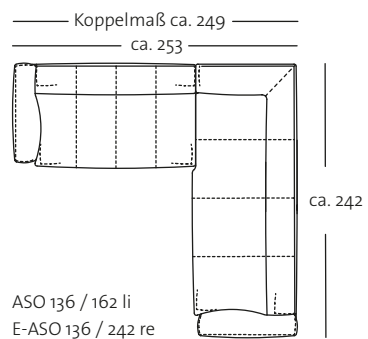
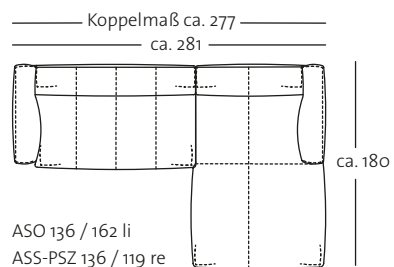
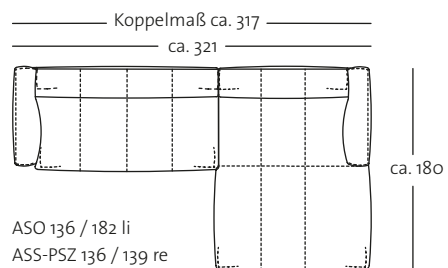



Design: Beck Design

freistil  
136

## PROFILE

### TECHNICAL DESIGN

- / Wooden inner frame
  - / Spring system: nosag spring
  - / Seat in polyurethane foam "density" 37 kg/m<sup>3</sup>, covered with a pad filled with foam fibre mix
  - / Back in polyurethane foam, "density" 30 kg/m<sup>3</sup>, covered with a pad filled with foam fibre mix
  - / Foot: steel single foot, powder coating jet black RAL 9005
- The data of "density" can vary in a range of +/- 10 %.

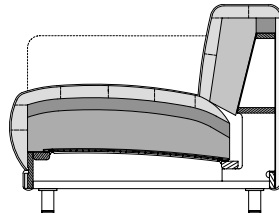

## LEG VERSIONS

Steel single foot,  
RAL 9005  
Jet black



## INFORMATION

- / Normal-depth models and over-depth models can be coupled together.
- / Ticking chamber webs in the pads can show through to the cover (= characteristic feature of high-grade upholstery pad workmanship).
- / The range is only suitable for velour covers to a limited extent. The fell seams and piping can lead to lines in the pile.
- / With modular systems, velour covers can lead to different pile alignments and therefore to different shine properties.
- / There are more dividing seams in leather covers than in fabric covers. Detailed information about this can be found in the Info section.
- / For ergonomic reasons, only the seat area of model ASS-PSZ – not the leg rest – is sprung. So if the leg rest is used as a seat it will feel much firmer.
- / Repeat and patterned fabrics cannot be processed with this range.
- / The cover material should be particularly soft and have a degree of thickness, due to the special corner stitching. Thin materials (especially fabrics) and materials that are strong along the fibre (leathers in particular) do not produce a harmonious overall appearance.



A high-quality, especially casual upholstery that forms waves/leaves indentations that are typical of the material. This waviness may even occur in new condition.

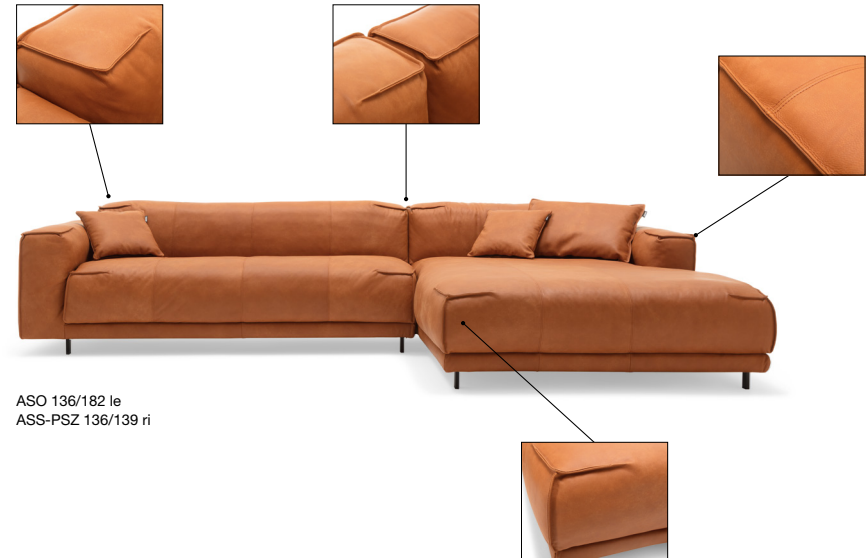

ASO 136/182 1e  
ASS-PSZ 136/139 ri



## OVERVIEW OF RANGE

### Front view/Top view

Sofa in widths: 183, 203, 223, 243 cm

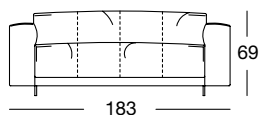

SOB 136/183

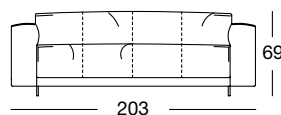

SOB 136/203

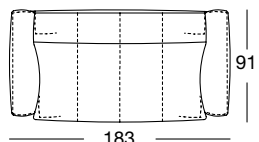

SOB 136/183

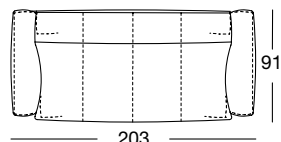

SOB 136/203

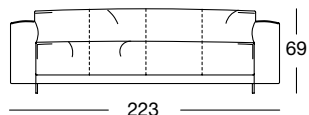

SOB 136/223

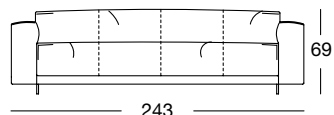

SOB 136/243

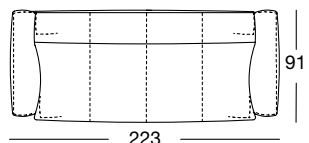

SOB 136/223

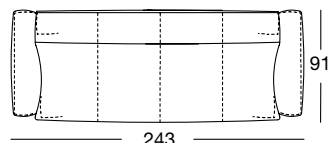

SOB 136/243

## OVERVIEW OF RANGE

### Front view/Top view

Sectional sofa in widths: 162, 182, 202 cm

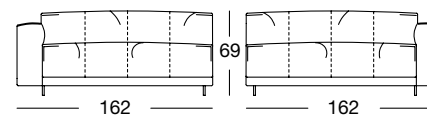

ASO 136/162 le

ASO 136/162 ri

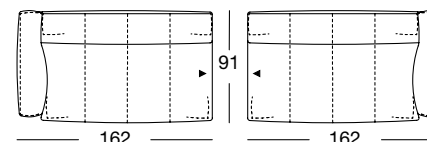

ASO 136/162 le

ASO 136/162 ri

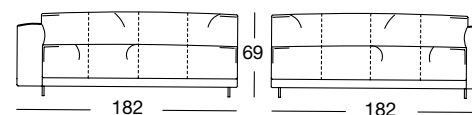

ASO 136/182 le

ASO 136/182 ri

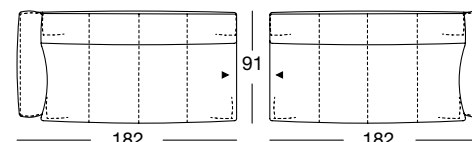

ASO 136/182 le

ASO 136/182 ri



## OVERVIEW OF RANGE

### Front view/Top view

Sectional sofa in widths: 162, 182, 202 cm

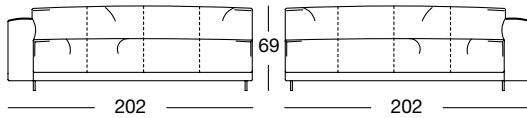

ASO 136/202 le

ASO 136/202 ri

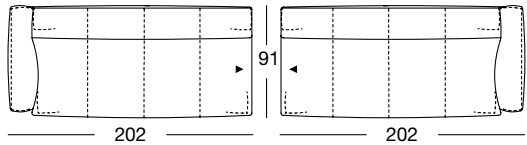

ASO 136/202 le

ASO 136/202 ri

Corner sectional sofa: 242 cm

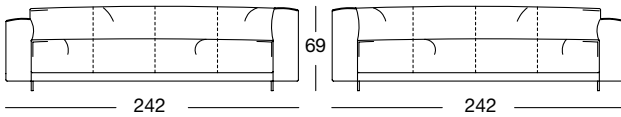

E-ASO 136/242 le

E-ASO 136/242 ri

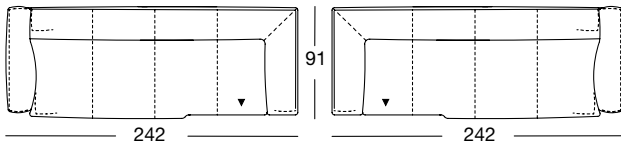

E-ASO 136/242 le

E-ASO 136/242 ri

## OVERVIEW OF RANGE

### Front view/Top view

Closing chair with fixed footstool: 119 und 139 cm

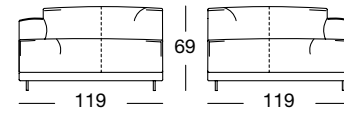

ASS-PSZ 136/119 le

ASS-PSZ 136/119 ri

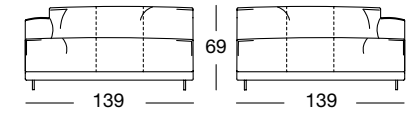

ASS-PSZ 136/139 le

ASS-PSZ 136/139 ri

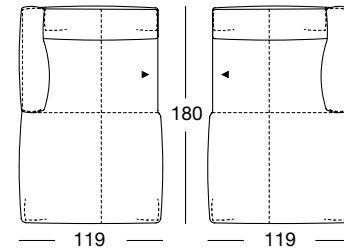

ASS-PSZ 136/119 le

ASS-PSZ 136/119 ri

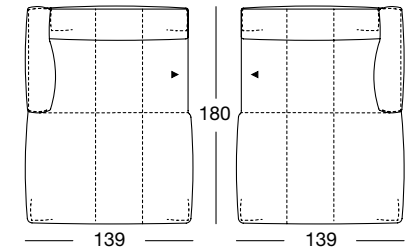

ASS-PSZ 136/139 le

ASS-PSZ 136/139 ri



## OVERVIEW OF RANGE

### Front view/Top view

#### Sectional bench with footstool: 164 cm

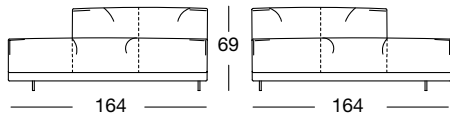

ARB-PSZ 136/164 le

ARB-PSZ 136/164 ri

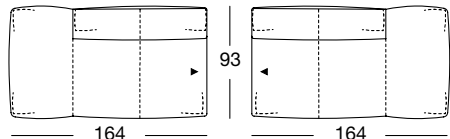

ARB-PSZ 136/164 le

ARB-PSZ 136/164 ri

#### Footstool: 104 x 74 cm

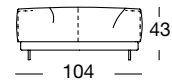

PB 136/104 x 74

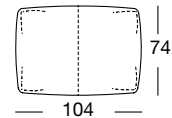

PB 136/104 x 74

### Side views

#### Normal depth

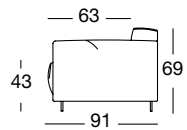

SOB 136/183

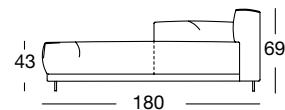

ASS-PSZ 136/119

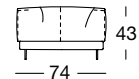

PB 136/104 x 74

#### Extra depth

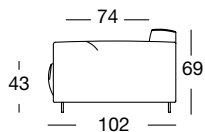

UE-SOB-ASO 136

## EXAMPLES OF COMBINATIONS

Examples of combinations are not shown to scale.

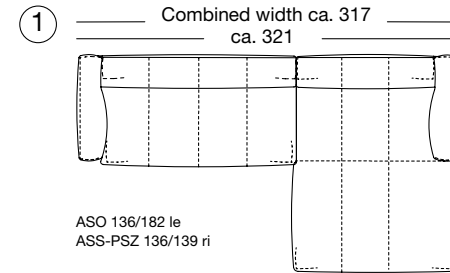

ASO 136/182 le  
ASS-PSZ 136/139 ri

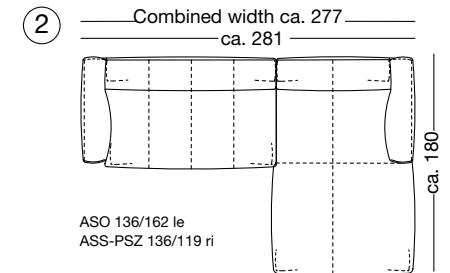

ASO 136/162 le  
ASS-PSZ 136/119 ri

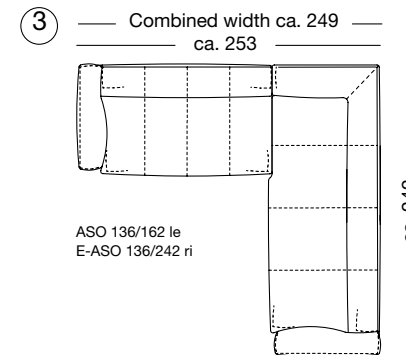

ASO 136/162 le  
E-ASO 136/242 ri