

## PROGRAMMÜBERSICHT

Program overview

Programma overzicht

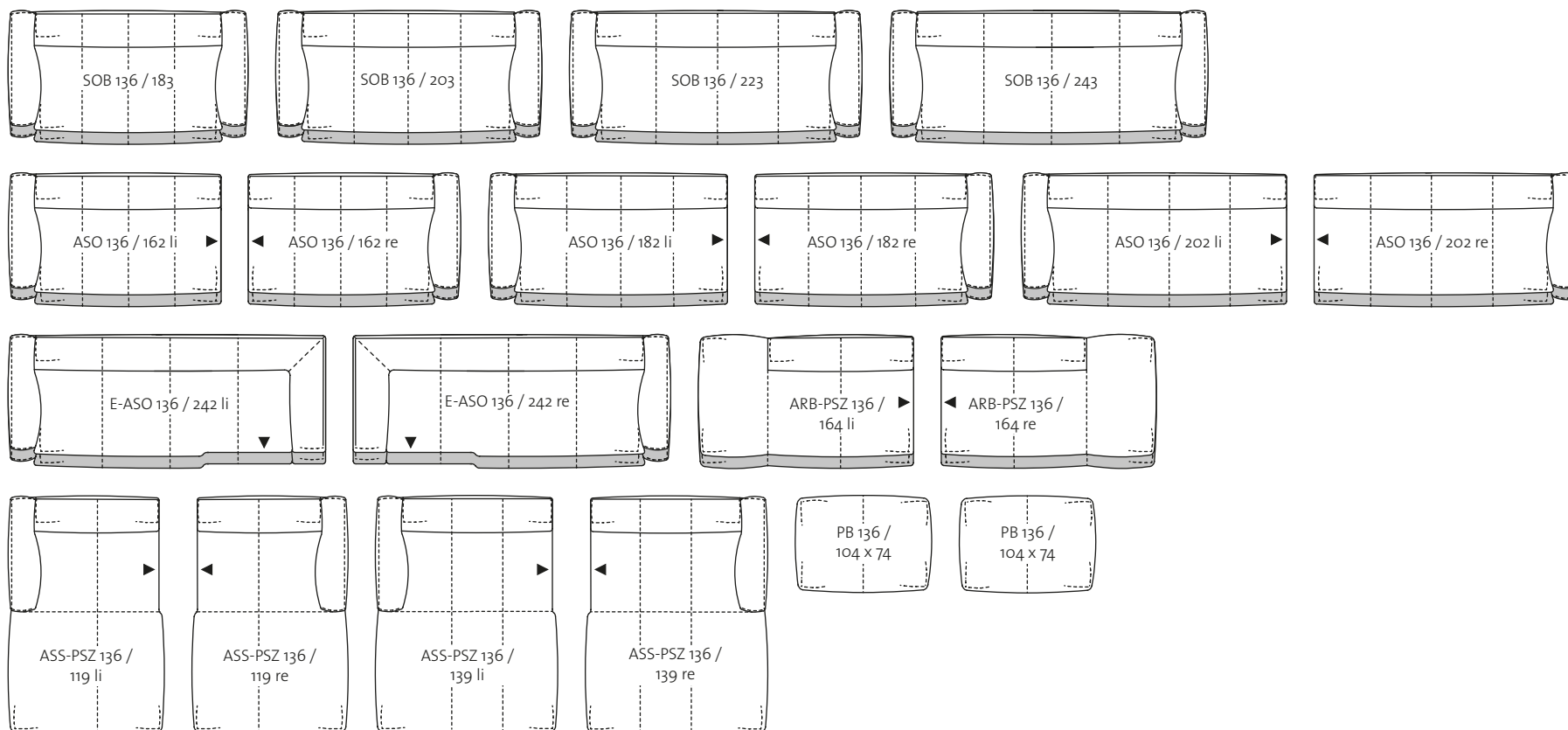

## KOMBINATIONENBEISPIELE

Combination examples

Voorbeelden van combinaties

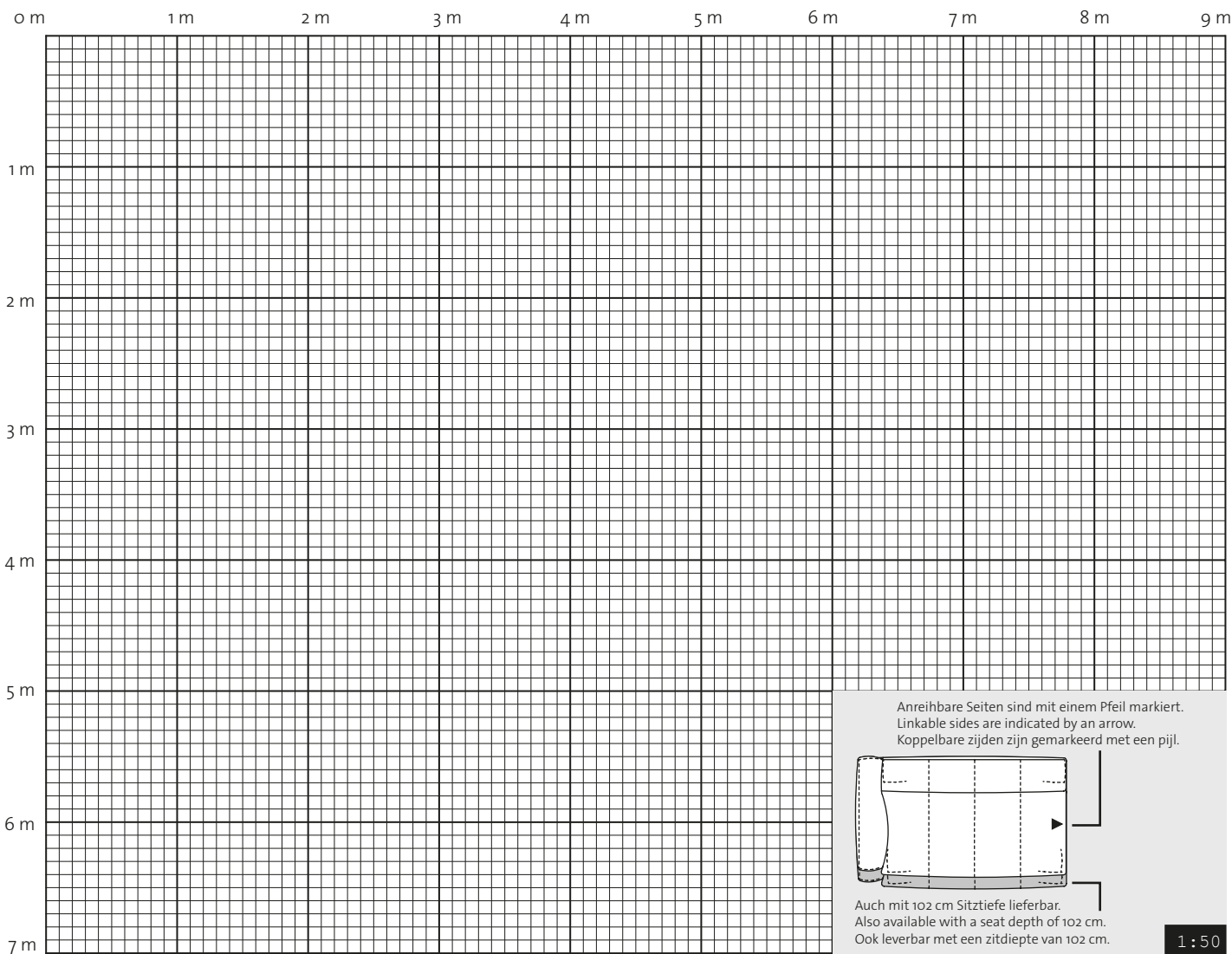
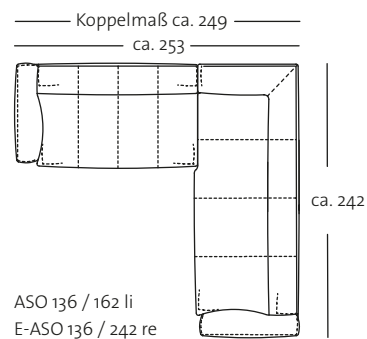
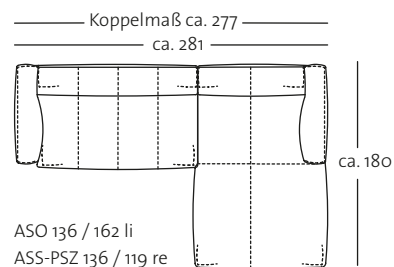
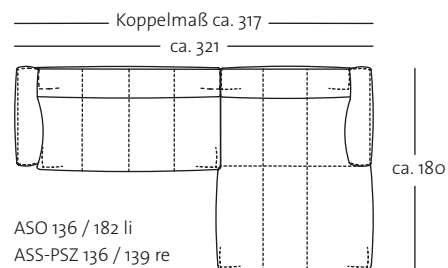

Anreihbare Seiten sind mit einem Pfeil markiert.  
Linkable sides are indicated by an arrow.  
Koppelbare zijden zijn gemarkeerd met een pijl.

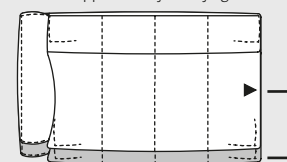

Auch mit 102 cm Sitztiefe lieferbar.  
Also available with a seat depth of 102 cm.  
Ook leverbaar met een zitdiepte van 102 cm.



Design: Beck Design

freistil  
136

## PROFILE

## TECHNICAL DESIGN

- Wooden inner frame
  - Spring system: nosag spring
  - Seat in polyurethane foam "density" 37 kg/m<sup>3</sup>, covered with a pad filled with foam fibre mix
  - Back in polyurethane foam, "density" 30 kg/m<sup>3</sup>, covered with a pad filled with foam fibre mix
  - Foot: steel single foot, powder coating jet black RAL 9005
- The data of "density" can vary in a range of +/- 10 %.

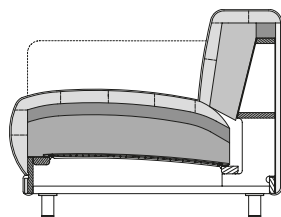

## LEG VERSIONS

Steel single  
foot,  
RAL 9005  
Jet black



## INFORMATION

- Normal-depth models and over-depth models can be coupled together.
- Ticking chamber webs in the pads can show through to the cover (= characteristic feature of high-grade upholstery pad workmanship).
- The range is only suitable for velour covers to a limited extent. The fell seams and piping can lead to lines in the pile.
- With modular systems, velour covers can lead to different pile alignments and therefore to different shine properties.
- There are more dividing seams in leather covers than in fabric covers. Detailed information about this can be found in the Info section.
- For ergonomic reasons, only the seat area of model ASS-PSZ – not the leg rest – is sprung. So if the leg rest is used as a seat it will feel much firmer.
- Repeat and patterned fabrics cannot be processed with this range.
- The cover material should be particularly soft and have a degree of thickness, due to the special corner stitching. Thin materials (especially fabrics) and materials that are strong along the fibre (leathers in particular) do not produce a harmonious overall appearance.

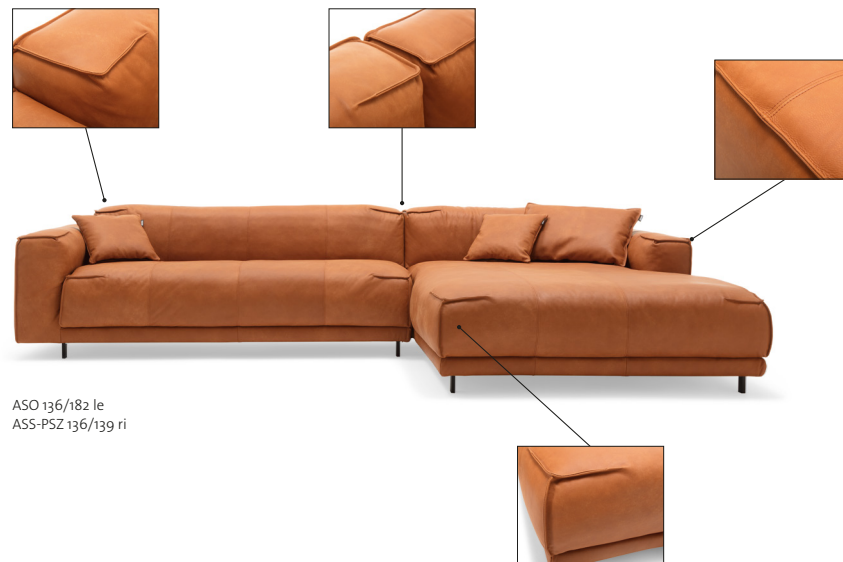

ASO 136/182 le  
ASS-PSZ 136/139 ri



## OVERVIEW OF RANGE

Front view/Top view

Sofa in widths: 183, 203, 223, 243 cm

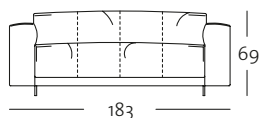

SOB 136/183

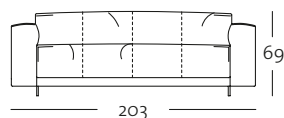

SOB 136/203

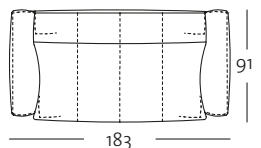

SOB 136/183

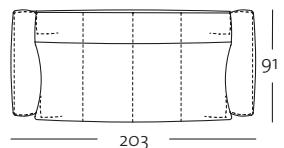

SOB 136/203

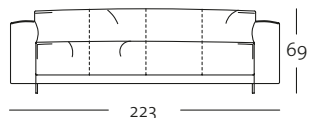

SOB 136/223

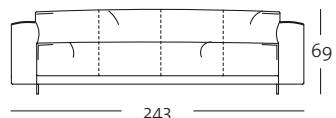

SOB 136/243

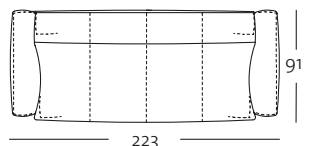

SOB 136/223

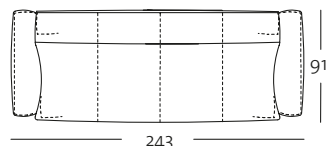

SOB 136/243

## OVERVIEW OF RANGE

Front view/Top view

Sectional sofa in widths: 162, 182, 202 cm

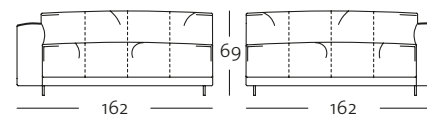

ASO 136/162 le

ASO 136/162 ri

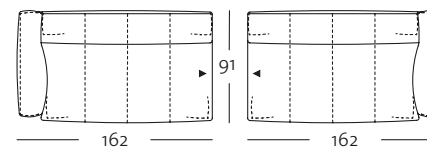

ASO 136/162 le

ASO 136/162 ri

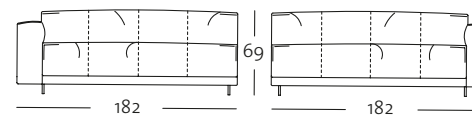

ASO 136/182 le

ASO 136/182 ri

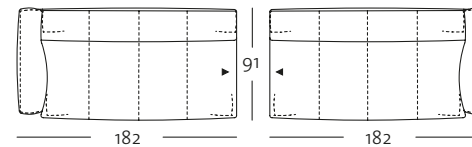

ASO 136/182 le

ASO 136/182 ri



## OVERVIEW OF RANGE

Front view/Top view

Sectional sofa in widths: 162, 182, 202 cm

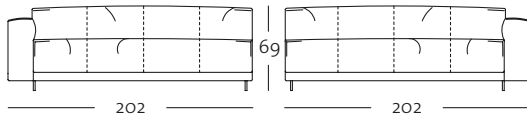

ASO 136/202 le

ASO 136/202 ri

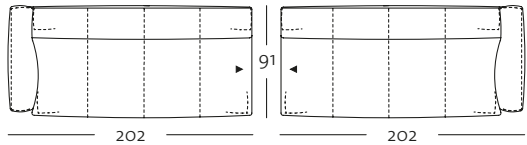

ASO 136/202 le

ASO 136/202 ri

Corner sectional sofa: 242 cm

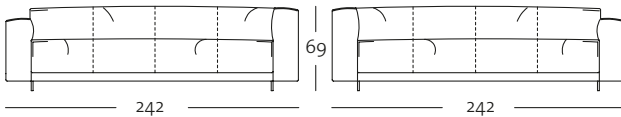

E-ASO 136/242 le

E-ASO 136/242 ri

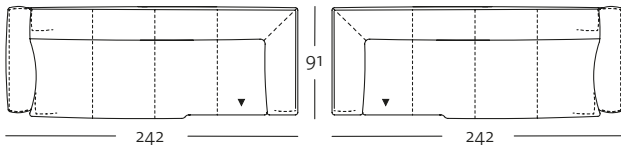

E-ASO 136/242 le

E-ASO 136/242 ri

## OVERVIEW OF RANGE

Front view/Top view

Closing chair with fixed footstool: 119 und 139 cm

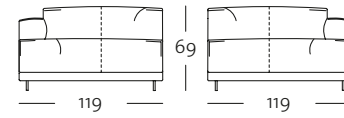

ASS-PSZ 136/119 le

ASS-PSZ 136/119 ri

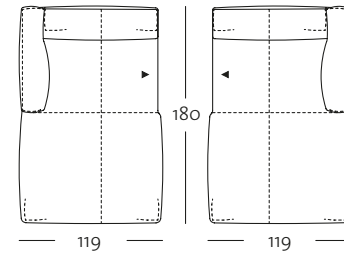

ASS-PSZ 136/119 le

ASS-PSZ 136/119 ri

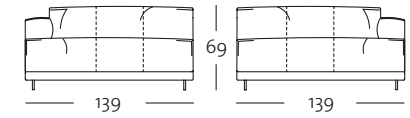

ASS-PSZ 136/139 le

ASS-PSZ 136/139 ri

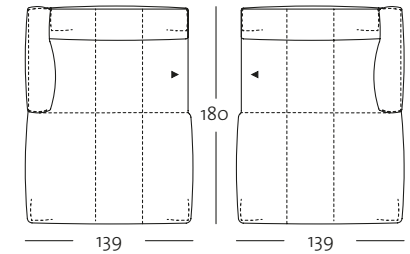

ASS-PSZ 136/139 le

ASS-PSZ 136/139 ri



## OVERVIEW OF RANGE

### Front view/Top view

Sectional bench with footstool: 164 cm

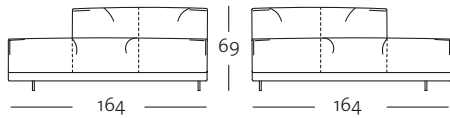

ARB-PSZ 136/164 le

ARB-PSZ 136/164 ri

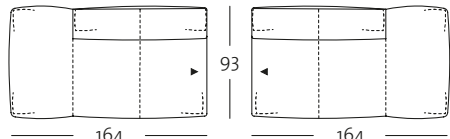

ARB-PSZ 136/164 le

ARB-PSZ 136/164 ri

Footstool: 104 x 74 cm

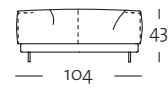

PB 136/104 x 74

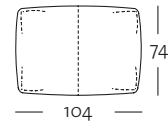

PB 136/104 x 74

### Side views

Normal depth

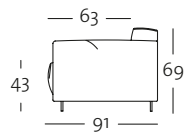

SOB 136/183

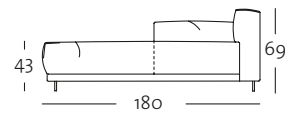

ASS-PSZ 136/119

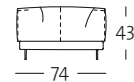

PB 136/104 x 74

Extra depth

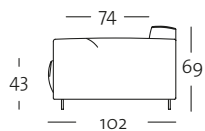

UE-SOB-ASO 136

## EXAMPLES OF COMBINATIONS

Examples of combinations are not shown to scale.

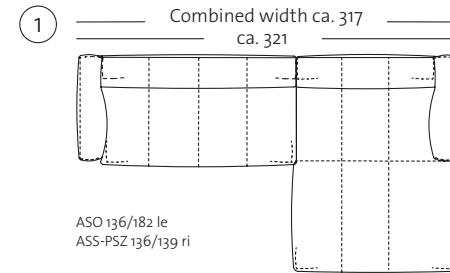

ASO 136/182 le  
ASS-PSZ 136/139 ri

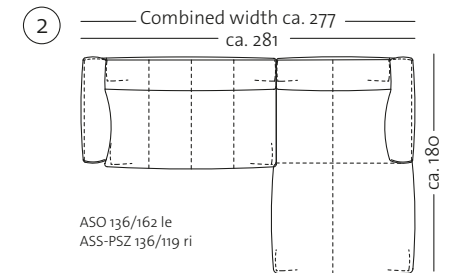

ASO 136/162 le  
ASS-PSZ 136/119 ri

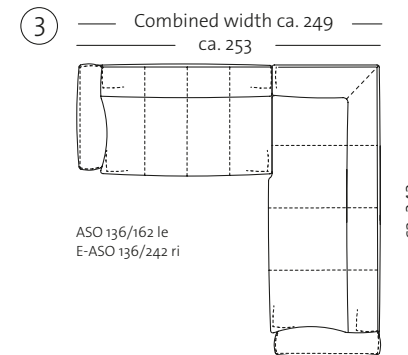

ASO 136/162 le  
E-ASO 136/242 ri