



Design: freistil Design-Team

freistil  
134

## PROFILE

## TECHNICAL DESIGN

- Wooden inner frame
- Spring system: nosag spring
- Seat cushions, chambered, attached with zips, filled with rhombus-shaped foam rods (90 %) and crimped, siliconised polyester fibres (10 %)
- Standard foot: tubular steel leg, RAL 9005 Jet black
- Loose back cushion, chambered, filled with rhombus-shaped foam rods (80 %) and crimped, siliconised polyester fibres (10 %)

The data of "density" can vary in a range of +/-10%.

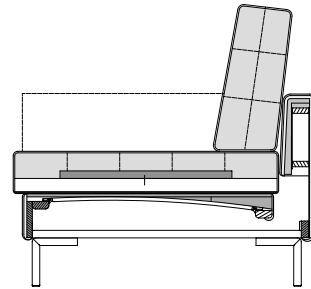

ASO / SOB 134

## INFORMATION

- Choice of seat height 43, 46 or 49 cm. However seat height 49 cm is only possible with the solid steel leg, tubular steel leg and tapered foot oak (even sloping conical bases). Please specify on ordering.
- The back cushions that are integrated in the models are also available as RUK-RO (back cushions with roll) for an additional charge. The roll prevents the cushions from sliding into the seat.
- Corner groups only of ASOs always consist of models with the same orientation: K-ASO left + K-ASO left, and K-ASO right + K-ASO right.
- With corner groups consisting of 2 or more modular sofas, the cushion gap in the corner can be filled with the backrest cushion RUK 60 x 48.
- This range is particularly loosely upholstered, so waviness is always visible on the surface of the upholstery.
- In addition to its function as shelving, the RU-ABL module can be used to increase the support function of the back cushion for a more upright sitting position.
- Ticking chamber webs in the pads can show through to the cover (= characteristic feature of high-grade upholstery pad workmanship).
- Repeat and patterned fabrics cannot be processed with this range.
- The range is only suitable for velour covers to a limited extent. The fell seams and piping can lead to lines in the pile.
- With modular systems, velour covers can lead to different pile alignments and therefore to different shine properties.
- There are more dividing seams in leather covers than in fabric covers. Detailed information about this can be found in the info section.
- For ergonomic reasons, only the seat area of model ASS-PSZ – not the leg rest – is sprung. So if the leg rest is used as a seat it will feel much firmer.

## LEG VERSIONS

Tubular steel leg, RAL 9005 Jet black



Steel leg, polished chrome



Steel leg, RAL 9005 Jet black



Tapered foot, oak natural



Tapered foot, oak brown stained



Solid steel leg, RAL 9005 Jet black



Tubular steel frame, polished chrome



Sloping conical base, oak natural



Sloping conical base, oak brown stained



Double round steel leg, RAL 9005 Jet black



Double round steel leg, RAL 1036 Pearl gold



Skidsquare steel tube, RAL 9005 Jet black



SOB 134/222  
1 x RUK 134/60 x 40  
(Solid steel leg, RAL 9005 Jet black)



ASO 134/202 le  
 ASS-PSZ 134/132 ri  
 RU-ABL 134  
 1 x KS-KI 134/60 x 26  
 3 x RUK 134/60 x 40  
 (Skidsquare steel tube, RAL 9005 Jet black)

**Backrest- and shelf plate**



Plate functions as a backrest-support for sitting up right



Plate can be used as a tray

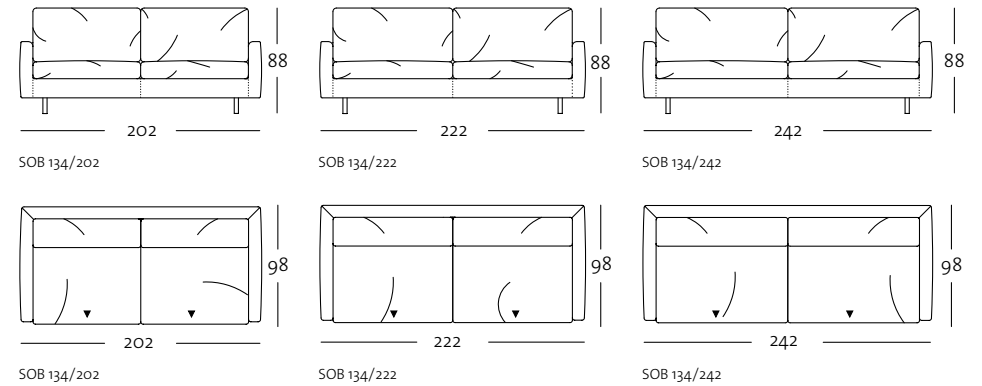

Plate can be used as a headrest-mount  
 \* Headrest-cushion: appropriate cushions available by order

**OVERVIEW OF RANGE**

**Front view/Top view**

Sofa in widths: 202, 222, 242 cm



Sectional sofa in widths: 142, 162, 182, 202 cm

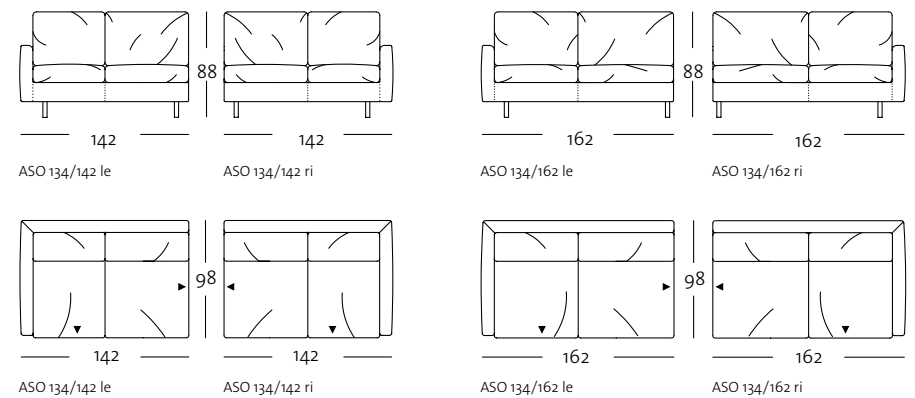



## OVERVIEW OF RANGE

### Front view/Top view

Sectional sofa in widths: 142, 162, 182, 202 cm

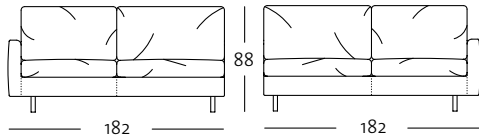

ASO 134/182 le

ASO 134/182 ri

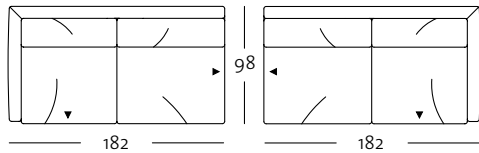

ASO 134/182 le

ASO 134/182 ri

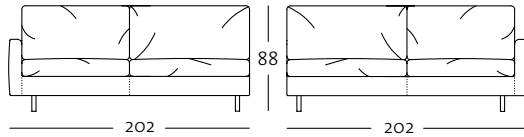

ASO 134/202 le

ASO 134/202 ri

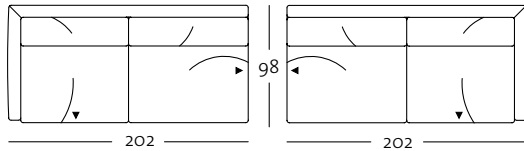

ASO 134/202 le

ASO 134/202 ri

## OVERVIEW OF RANGE

### Front view/Top view

Closing chair with fixed footstool: 112 cm and 132 cm

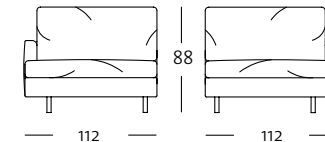

ASS-PSZ 134/112 le

ASS-PSZ 134/112 ri

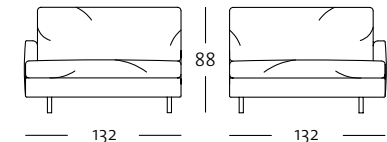

ASS-PSZ 134/132 le

ASS-PSZ 134/132 ri

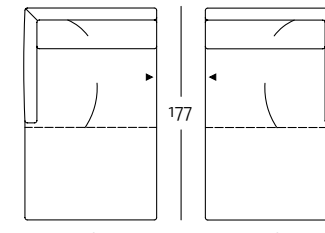

ASS-PSZ 134/112 le

ASS-PSZ 134/112 ri

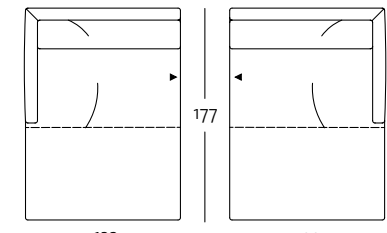

ASS-PSZ 134/132 le

ASS-PSZ 134/132 ri

Corner unit: 98 cm x 98 cm

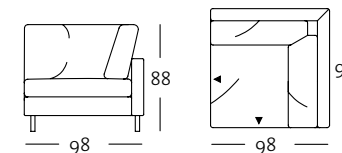

EPT 134/98

EPT 134/98



## OVERVIEW OF RANGE

### Front view/Top view

Footstool: 86 x 97 cm (extra depth) or 86 x 54 cm

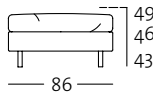

UE-PB 134/86 x 97

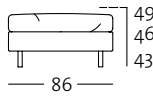

PB 134/86 x 54

### Side view

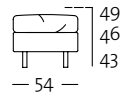

PB 134/86 x 54

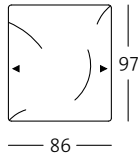

UE-PB 134/86 x 97

Recommended back cushion for corner combinations (see example 2)

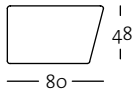

RUK 134/80 x 48 le

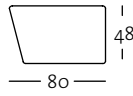

RUK 134/80 x 48 ri

### Front view/Top view/Side view

Headrest-cushion and Backrest- and shelf plate (for use as headrest)

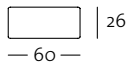

KS-KI 134/60 x 26

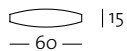

KS-KI 134/60 x 26



KS-KI 134/60 x 26

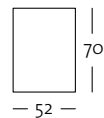

RU-ABL 134

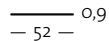

RU-ABL 134

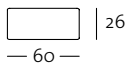

ST-KI 134/60 x 26

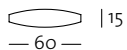

ST-KI 134/60 x 26



ST-KI 134/60 x 26

## OVERVIEW OF RANGE

### Side view

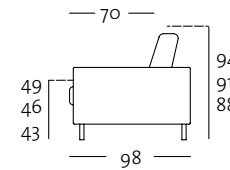

SOB 134/ASO 134

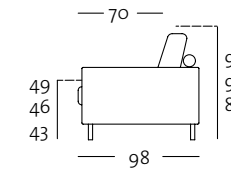

SOB 134/ASO 134  
incl. back cushion with roll

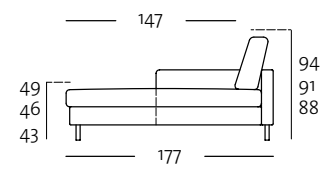

ASS-PSZ 134

## EXAMPLES OF COMBINATIONS

Examples of combinations are not shown to scale.

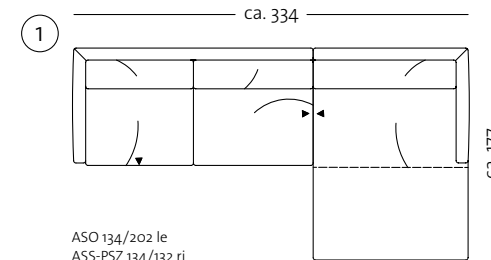

ASO 134/202 le  
ASS-PSZ 134/132 ri

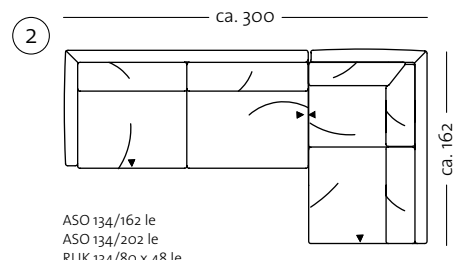

ASO 134/162 le  
ASO 134/202 le  
RUK 134/80 x 48 le