



Design: freistil Design-Team

freistil  
121

## PROFILE

## TECHNICAL DESIGN

- / Wooden inner frame
- / Spring system: nosag spring
- / Seat in polyurethane foam "density" 37 kg/m<sup>3</sup>
- / Back in polyurethane foam, "density" 30 kg/m<sup>3</sup>
- / Standard foot: plastic

The data of "density" can vary in a range of +/- 10 %.

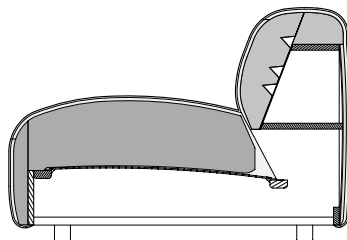

## LEG VERSIONS

Plastic leg  
(standard foot)



UE-ASO 121/SB120 le  
UE-ASO 121/SB120 ri



ASO 121/SB140 le  
ALC 121/SB120 ri

## INFORMATION

- / Seat depth optionally 72 cm or 92 cm.
- / Seating elements with different seat depths cannot be connected to each other.
- / The different seat depths are visually separated from each other by a different design.
- / A high-quality, especially casual upholstery that forms waves/ leaves indentations that are typical of the material. This waviness may even occur in new condition.
- / All microfibre materials and velour fabrics are excluded from this programme.
- / The decorative seams on the outer sides differ between fabric and leather. In fabric, the decorative seam is a 1.5 cm wide felled seam filled with a profile, creating a very vivid seam appearance. In leather, this seam is designed as an 8 mm wide felled seam.
- / When the A-PB (add-on upholstered bench) is connected, a height offset occurs towards the rear, at the seat of the adjoining model. This offset results from the fact that all other models have a seat incline. The seating comfort of the A-PB models differs from that of the other models. No under-suspension is installed here, therefore the seating feel may be different.
- / There are more dividing seams in leather covers than in fabric covers. Detailed information about this can be found in the Info section.
- / For ergonomic reasons, only the seat area of model ALC – not the leg rest – is sprung. So if the leg rest is used as a seat it will feel much firmer.
- / Repeat and patterned fabrics cannot be processed with this range.



A high-quality, especially casual upholstery that forms waves/ leaves indentations that are typical of the material. This waviness may even occur in new condition.



Design: freistil Design-Team

freistil  
121

## OVERVIEW OF RANGE

### Front view/Top view

Closing sofa in four widths: 104, 124, 144, 164 cm

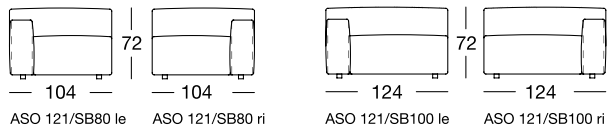

ASO 121/SB80 le ASO 121/SB80 ri ASO 121/SB100 le ASO 121/SB100 ri

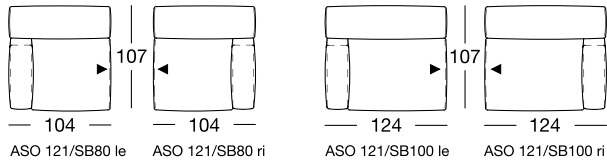

ASO 121/SB80 le ASO 121/SB80 ri ASO 121/SB100 le ASO 121/SB100 ri

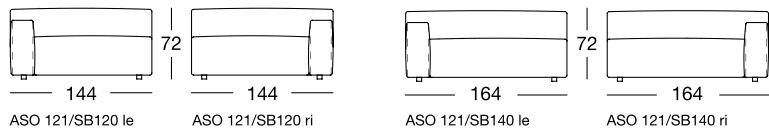

ASO 121/SB120 le ASO 121/SB120 ri ASO 121/SB140 le ASO 121/SB140 ri

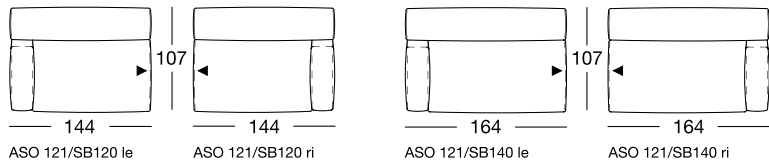

ASO 121/SB120 le ASO 121/SB120 ri ASO 121/SB140 le ASO 121/SB140 ri

## OVERVIEW OF RANGE

### Front view/Top view

Closing chair with fixed footstool: 160 cm

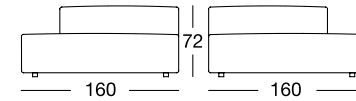

ARB-PSZ 121/SB160 li ARB-PSZ 121/SB160 re

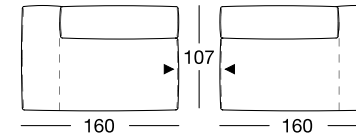

ARB-PSZ 121/SB160 li ARB-PSZ 121/SB160 re

Sectional-Upholstered bench  
in two widths: 80 x 109, 100 x 109 cm

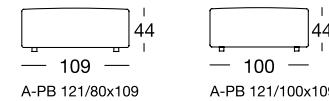

A-PB 121/80x109 A-PB 121/100x109

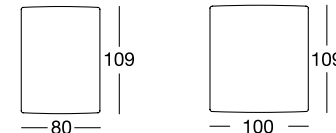

A-PB 121/80x109 A-PB 121/100x109

Sectional sofa in two widths: 80, 120 cm

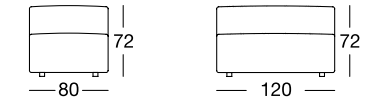

ARB 121/SB80 ARB 121/SB120

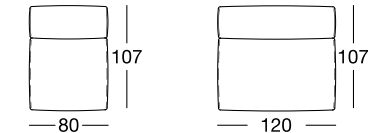

ARB 121/SB80 ARB 121/SB120

Footstool:  
63 x 48 cm

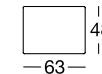
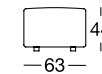

Corner unit: 123 x 123 cm

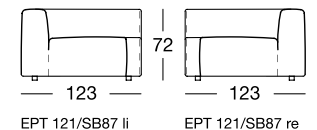

EPT 121/SB87 li EPT 121/SB87 re

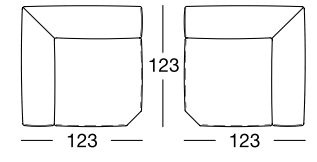

EPT 121/SB87 li EPT 121/SB87 re



Design: freistil Design-Team

freistil  
121

## OVERVIEW OF RANGE

### Front view/Top view

Closing-Longchair in four widths: 124 x 188, 144 x 188, 124 x 228, 144 x 228 cm

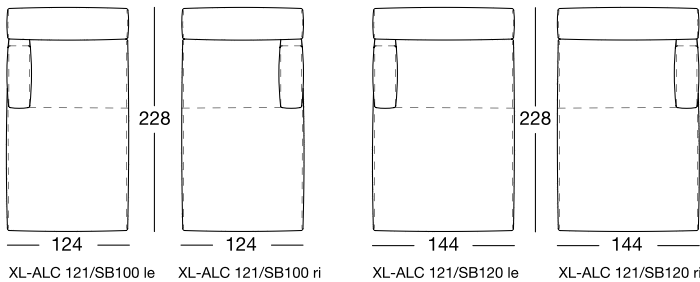
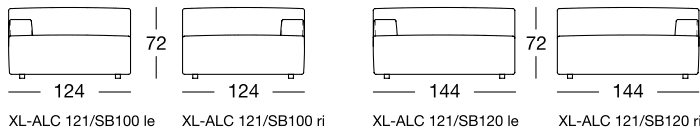
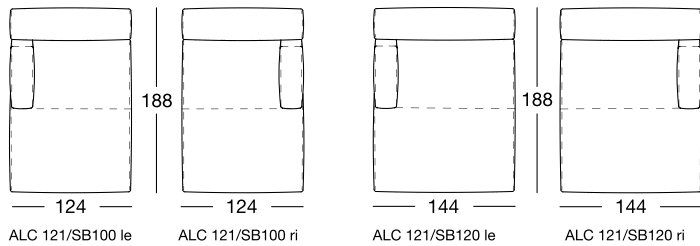
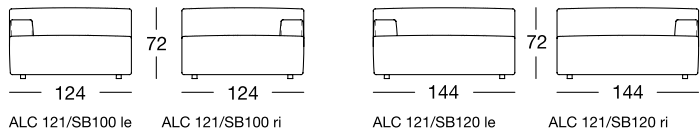

SOFAS freistil 121

### Side view

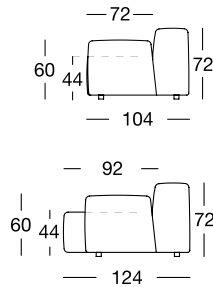

Overview of range scale 1:50

## EXAMPLES OF COMBINATIONS

### Front view/Top view

Recommended cushions in widths: 80 x 62, 88 x 68 cm

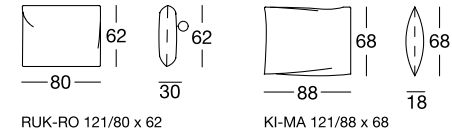

## EXAMPLES OF COMBINATIONS

Examples of combinations are not shown to scale.

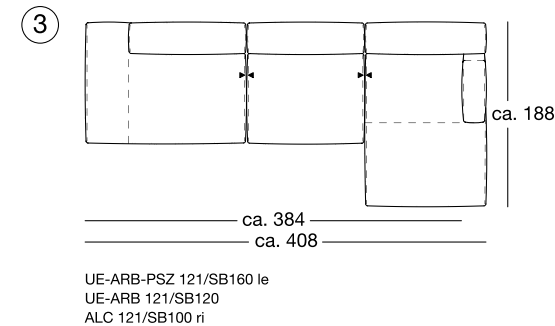
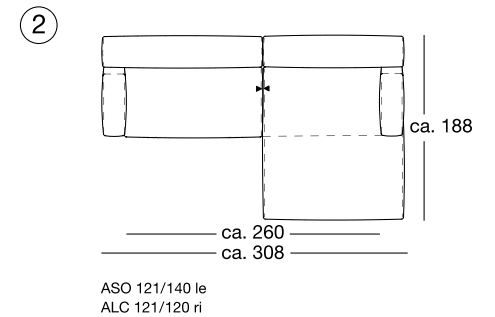
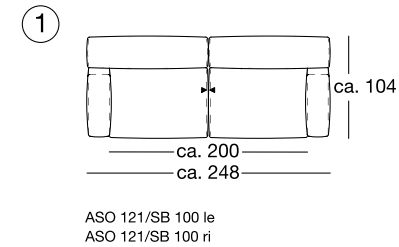

freistil 121 SOFAS